

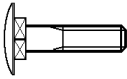

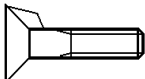

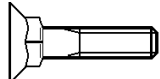

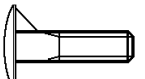

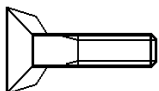

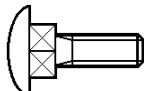
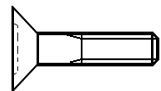

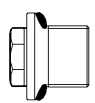
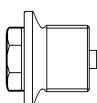
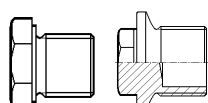
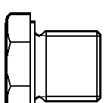
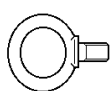

- 1 - 	- 2 - 	- 3 - 	- 4 - 
- 5 - 	- 6 - 	- 7 - 	- 8 - 
- 9 - 	- 10 - 	- 11 - 	- 12 - 
- 13 - 	- 14 - 	- 15 - 	- 16 - 
- 17 - 	- 18 - 	- 19 - 	- 20 - 
- 21 - 	- 22 - 	- 23 - 	- 24 - 
- 25 - 	- 26 - 	- 27 - 	- 28 - 
- 29 - 	- 30 - 	- 31 - 	- 32 - 

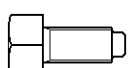
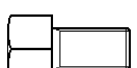
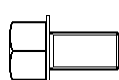
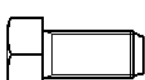
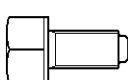
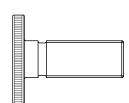
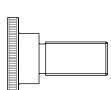
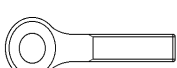
**SWEBOLT AB**

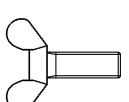
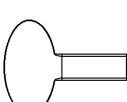
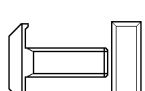
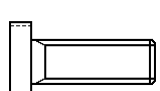
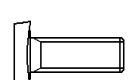
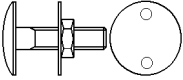
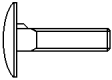
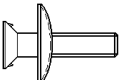
TEL. 08-584 909 60 FAX. 08-583 581 82

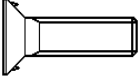
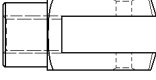
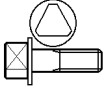
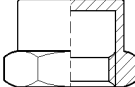
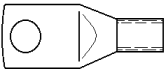
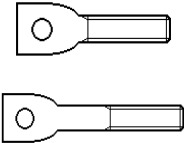
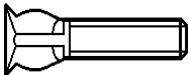
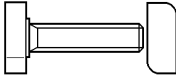
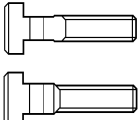
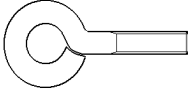
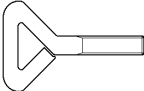
- 33 - 	- 34 - 	- 35 - 	- 36 - 
- 37 - 	- 38 - 	- 39 - 	- 40 - 
- 41 - 	- 42 - 	- 43 - 	- 44 - 
- 45 - 	- 46 - 	- 47 - 	- 48 - 
- 49 - 	- 50 - 	- 51 - 	- 52 - 
- 53 - 	- 54 - 	- 55 - 	- 56 - 
- 57 - 	- 58 - 	- 59 - 	- 60 - 
- 61 - 	- 62 - 	- 63 - 	- 64 - 

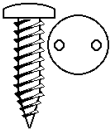
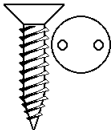
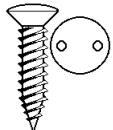
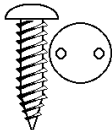
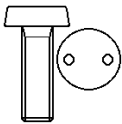
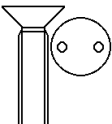
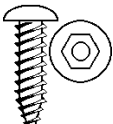
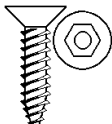
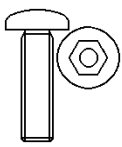
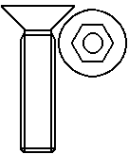
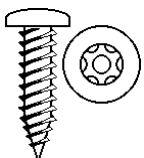
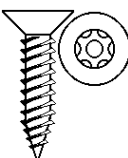
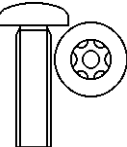
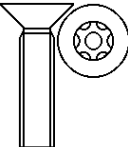
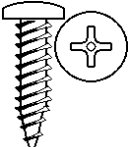
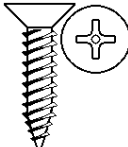
**SWEBOLT AB**

TEL. 08-584 909 60 FAX. 08-583 581 82

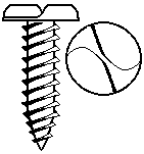
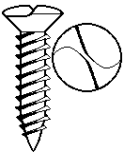
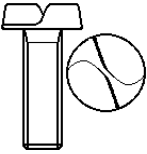
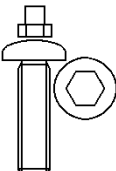
<p style="text-align: center;">- 65 -</p> 	<p style="text-align: center;">- 66 -</p> 	<p style="text-align: center;">- 67 -</p> 	<p style="text-align: center;">- 68 -</p> 
<p style="text-align: center;">- 69 -</p>	<p style="text-align: center;">- 70 -</p>	<p style="text-align: center;">- 71 -</p>	<p style="text-align: center;">- 72 -</p>
<p style="text-align: center;">- 73 -</p>	<p style="text-align: center;">- 74 -</p>	<p style="text-align: center;">- 75 -</p>	<p style="text-align: center;">- 76 -</p>
<p style="text-align: center;">- 77 -</p>	<p style="text-align: center;">- 78 -</p>	<p style="text-align: center;">- 79 -</p>	<p style="text-align: center;">- 80 -</p>
<p style="text-align: center;">- 81 -</p>	<p style="text-align: center;">- 82 -</p>	<p style="text-align: center;">- 83 -</p>	<p style="text-align: center;">- 84 -</p>
<p style="text-align: center;">- 85 -</p>	<p style="text-align: center;">- 86 -</p>	<p style="text-align: center;">- 87 -</p>	<p style="text-align: center;">- 88 -</p>
<p style="text-align: center;">- 89 -</p>	<p style="text-align: center;">- 90 -</p>	<p style="text-align: center;">- 91 -</p>	<p style="text-align: center;">- 92 -</p>
<p style="text-align: center;">- 93 -</p>	<p style="text-align: center;">- 94 -</p>	<p style="text-align: center;">- 95 -</p>	<p style="text-align: center;">- 96 -</p>

**SWEBOLT AB**

TEL. 08-584 909 60 FAX. 08-583 581 82

## PRODUKTER I STÅL

1	110001	MVBF, VAGNSBULT	603	8677	4.6	OBEH	10:1
1	110002	MVBF, VAGNSBULT	603	8677	4.6	FZB	10:1
1	710003	MVBF, VAGNSBULT	603	8677	4.6	DEPO	10:7
1	110004	MVBF, VAGNSBULT	603	8677	8.8	OBEH	10:8
1	110005	MVBF, VAGNSBULT	603	8677	8.8	FZB	10:8
1	110006	MVBF, VAGNSBULT	603	8677	8.8	FZV	10:8
1	110008	UVBF, VAGNSBULT UNC	603		4.6	OBEH	10:27
1	110009	UVBF, VAGNSBULT UNC	603		4.6	FZB	10:27
2	110010	MVBFFK, FÖRS. m. KNASTER	604		4.6	OBEH	10:9
2	110011	MVBFFK, FÖRS. m. KNASTER	604		4.6	FZB	10:9
3	110015	MVBFF, FÖRSÄNKT VAGNSBULT	605		4.6	OBEH	10:10
3	110016	MVBFF, FÖRSÄNKT VAGNSBULT	605		4.6	FZB	10:10
3	110017	MVBFF, FÖRSÄNKT VAGNSBULT	608		4.6	OBEH	10:11
3	110018	MVBFF, FÖRSÄNKT VAGNSBULT	608		8.8	OBEH	10:11
4	110020	MVBFK, VAGNSB. m. KNASTER	607		4.6	OBEH	10:12
4	110021	MVBFK, VAGNSB. m. KNASTER	607		4.6	FZB	10:12
5	110025	KLÄMSKRUV				OBEH	10:13
5	110026	KLÄMSKRUV				FZB	10:13
5	110035	FÖRSÄNKT m. TVÅ KNASTER	25195			OBEH	10:13
5	110036	FÖRSÄNKT m. TVÅ KNASTER	25195			FZB	10:13
6	110040	VÄGRÄCKESSKRUV			4.6	FZV	10:14
7	110045	VHSS, VÄGHYVELSKRUV			8.8	OBEH	10:14
8	110046	MFSS, FÖRSÄNKT, MEJSELSPÅR	7969		4.6	OBEH	10:14
8	110047	MFSS, FÖRSÄNKT, MEJSELSPÅR	7969		4.6	FZB	10:14
9	110050	RP 906, KONISK, INV. 6-KANT	906	M+R	5.8	OBEH	10:2
9	110051	RP 906, KONISK, INV. 6-KANT	906	M+R	5.8	FOS	10:2
9	110052	RP 906, KONISK, INV. 6-KANT	906	M+R	5.8	FZB	10:2
10	110055	RP 908, INV. 6-KANT m. FLÄNS	908	M+R	5.8	OBEH	10:2
10	110056	RP 908, INV. 6-KANT m. FLÄNS	908	M+R	5.8	FOS	10:2
10	110057	RP 908, INV. 6-KANT m. FLÄNS	908	M+R	5.8	FZB	10:2
11	110060	RP 908T, FLÄNS OCH TÄTNING	908	M+R	5.8	OBEH	10:15
12	110065	RP 910, 6-KANT	910	M+R	5.8	OBEH	10:2
12	110066	RP 910, 6-KANT	910	M+R	5.8	FOS	10:2
12	110067	RP 910, 6-KANT	910	M+R	5.8	FZB	10:2
13	110070	RP 910T, 6-KANT m. TÄTNING	910	M+R	5.8	OBEH	10:15
14	110075	RP 910M, 6-KANT, MAGNETISK	910	M+R	5.8	OBEH	10:15
15	110080	RP, 6-KANT, METRISK GÄNGA	7604A+C		5.8	OBEH	10:17
15	110081	RP, 6-KANT, METRISK GÄNGA	7604A		5.8	FZB	10:17
15	110083	RP, 6-KANT, METRISK GÄNGA	7604C		5.8	FZB	10:17
16	110085	RP, 6-KANT, RÖRGÄNGA	7604C		5.8	FZB	10:17

**SWEBOLT AB**

TEL. 08-584 909 60 FAX. 08-583 581 82

BILD	ART.GR.	BENÄMNING	DIN	ISO	KVAL	YTBEH	SIDA
17	110100	LT, LYFTÖGLA, TAPP	580	3266	C15	OBEH	10:4
17	110101	LT, LYFTÖGLA, TAPP	580	3266	C15	FZB	10:4
17	110102	LT, LYFTÖGLA, TAPP	580	3266	C15	FZV	10:4
17	110105	LT, LYFTÖGLA, TAPP, UNC	580	3266	C15	OBEH	10:26
17	110106	LT, LYFTÖGLA, TAPP, UNC	580	3266	C15	FZB	10:26
17	110107	LT, LYFTÖGLA, TAPP, UNC	580	3266	C15	FZV	10:26
18	110110	LH, LYFTÖGLA, HÅL	582		C15	OBEH	10:4
18	110111	LH, LYFTÖGLA, HÅL	582		C15	FZB	10:4
18	110112	LH, LYFTÖGLA, HÅL	582		C15	FZV	10:4
18	110115	LH, LYFTÖGLA, HÅL, UNC	582		C15	OBEH	10:26
18	110116	LH, LYFTÖGLA, HÅL, UNC	582		C15	FZB	10:26
18	110117	LH, LYFTÖGLA, HÅL, UNC	582		C15	FZV	10:26
19	110120	T6SS, STÄLLSKR., 6-KANT, TAPP	561B		8.8	OBEH	10:20
20	110130	USK4SS, STÄLLSKRUV, 4-KANT				OBEH	10:20
21	110140	MSK4F, 4-KANT m. FLÄNS	478		8.8	OBEH	10:21
21	110142	MSK4F, 4-KANT m. FLÄNS	478		10.9	OBEH	10:21
22	110150	T4SS, STÄLLSKRUV	479		8.8	OBEH	10:21
22	110152	T4SS, STÄLLSKRUV	479		10.9	OBEH	10:21
23	110160	4-KANT m. TAPP OCH FLÄNS	480		8.8	OBEH	10:21
23	110165	4-KANT m. TAPP OCH FLÄNS	480		10.9	OBEH	10:21
24	110170	LETTERSKRUV	653		5.8	OBEH	10:6
24	110171	LETTERSKRUV	653		5.8	FZB	10:6
25	110180	LETTERSKRUV m. ANSATS	464		5.8	OBEH	10:6
25	110181	LETTERSKRUV m. ANSATS	464		5.8	FZB	10:6
26	110200	LS, LÄNKSKRUV	444 A,B,C		4.6	OBEH	10:22
26	110201	LS, LÄNKSKRUV	444 A,B,C		4.6	FZB	10:22
26	110203	LS, LÄNKSKRUV	444 A,B,C		8.8	OBEH	10:23
26	110204	LS, LÄNKSKRUV	444 A,B,C		8.8	FZB	10:23
26	110206	LS, LÄNKSKRUV	SMS			OBEH	10:24
26	110207	LS, LÄNKSKRUV	SMS			FZB	10:24
27	110210	HS, HAMMARSKRUV	186		4.6	OBEH	10:25
27	110211	HS, HAMMARSKRUV	186		4.6	FZB	10:25
28	110220	VS, VINGSKRUV	316			OBEH	10:5
28	110221	VS, VINGSKRUV	316			FZB	10:5
29	110230	BS, BLADSKRUV				OBEH	10:16
29	110230	BS, BLADSKRUV				FZB	10:16
30	110300	UHS, UPPHÄNGNINGSSKRUV			4.6	OBEH	10:30
30	110301	UHS, UPPHÄNGNINGSSKRUV			4.6	FZB	10:30

**SWEBOLT AB**

TEL. 08-584 909 60 FAX. 08-583 581 82

BILD	ART.GR.	BENÄMNING	DIN	ISO	KVAL	YTBEH	SIDA
31	110310	SS, SKENSKRUV				OBEH	10:30
31	110311	SS, SKENSKRUV				FZB	10:30
32	110320	SUHS, UPPHÄNGNINGSSKRUV, SMAL				OBEH	10:31
32	110321	SUHS, UPPHÄNGNINGSSKRUV, SMAL				FZB	10:31
33	110400	ELEVATORSK., INKL. MUTTER o. BRICKA				FZB	10:32
34	110405	ELEVATORSK., MED NIBB				FZB	10:32
35	110410	ELEVATORSK., LÅSTAPP MED MUTTER o. BRICKA				FZB	10:33
36	110415	ELEVATORSK., MUTTER+LÅSTAPP				FZB	10:33
37	110420	FÖRSÄNKT ELEVATORSK., MUTTER+LÅSTAPP				FZB	10:33
38	110430	GAFFELLÄNK	71752			OBEH	10:34
39	110440	M3S, TREKANTSSKRUV				OBEH	10:34
40	110460	RF, FÖRSLUTNING	7605			OBEH	10:35
40	110461	RF, FÖRSLUTNING	7605			FZB	10:35
41	110470	BLADHYLSA				OBEH	10:5
41	110471	BLADHYLSA				FZB	10:5
42	110425	PS, PENDELSKRUV				FZB	10:5
43	110028	DS, DRAGSKRUV				FZB	10:13
44	110511	SKENSKRUV				FZB	10:31
45	110600	TB, T-SPÅRSBULT	787			FZB	10:36
46	110610	SÖ, SKRUVÖGLA				OBEH	10:6
46	110611	SÖ, SKRUVÖGLA				FZB	10:6
46	110612	SÖS, FÖRANKRINGSÖGLA SVETSAD				OBEH	
46	110613	SÖS, FÖRANKRINGSÖGLA SVETSAD				FZB	
47	110615	SÖT, SKRUVÖGLA, TREKANT				OBEH	10:37
47	110616	SÖT, SKRUVÖGLA, TREKANT				FZB	10:37
48	110620	VKM, VINKELKROK				OBEH	10:37
48	110621	VKM, VINKELKROK				FZB	10:37

### ROSTFRITT / SYRAFAST

1	210001	MVBF, VAGNSBULT	603	8677	A2		10:41
1	210002	MVBF, VAGNSBULT	603	8677	A4		10:41
9	210050	RP 906, KONISK, INV. 6-KANT	906	M+R	A2		10:42
9	210051	RP 906, KONSIK, INV. 6-KANT	906	M+R	A4		10:42

**SWEBOLT AB**

TEL. 08-584 909 60 FAX. 08-583 581 82

BILD	ART.GR.	BENÄMNING	DIN	ISO	KVAL	YTBEH	SIDA
10	210055	RP 908, INV. 6-KANT m. FLÄNS	908	M+R	A2		10:42
10	210056	RP 908, INV. 6-KANT m. FLÄNS	908	M+R	A4		10:42
12	210065	RP 910, 6-KANT	910	M+R	A2		10:42
12	210066	RP 910, 6-KANT	910	M+R	A4		10:42
17	210100	LT, LYFTÖGLA, TAPP	580		A2		10:43
17	210101	LT, LYFTÖGLA, TAPP	580		A4		10:43
18	210110	LH, LYFTÖGLA, HÅL	582		A2		10:43
18	210111	LH, LYFTÖGLA, HÅL	582		A4		10:43
26	210200	LS, LÄNKSKRUV	444 B		A2		10:45
26	210201	LS, LÄNKSKRUV	444 B		A4		10:45
27	210210	HS, HAMMARSKRUV	186		A2		10:45
27	210211	HS, HAMMARSKRUV	186		A4		10:45
28	210220	VS, VINGSKRUV, AM-TYP	316		A2		10:44
28	210221	VS, VINGSKRUV, AM-TYP	316		A4		10:44
46	210610	SÖ, SKRUVÖGLA			A2		10:46
46	210611	SÖ, SKRUVÖGLA			A4		10:46

### MÄSSING

1	310001	MVBF, VAGSBULT	603	8677			10:60
9	310050	RP-906, KONISK, INV. 6-KANT	906				10:61
10	310055	RP-908, INV. 6-KANT m. FLÄNS	908				10:61
12	310065	RP-910, 6-KANT	910				10:61
12	311066	RP-910, 6-KANT	910			FÖRNICKLAD	10:61
15	310080	RP, 6-KANT, METRISK GÄNGA	7604A				10:62
24	310170	LETTERSKRUV	653				10:62
28	310220	VS, VINGSKRUV	316				10:62
28	310221	VS, VINGSKRUV	316			FÖRNICKLAD	10:62

### POLYAMID

16	410088	FS, FÖRSLUTNINGSSKRUV					10:70
28	410220	VS, VINGSKRUV	316				10:70

**SWEBOLT AB**

TEL. 08-584 909 60 FAX. 08-583 581 82



**ARTIKELLISTA**  
**2013-2014**  
**VAGNSBULT**  
**BLANKFÖRZINKAD**  
**MVBF 4.6 FZB DIN 603**

GÄNGA	M5	M6	M8	M10	M12	M16	M20
Skalldiam	13.6	16	20	24	30	38	46
Skallhöjd	3.3	3.5	4.5	5	6.5	8.5	10.5
4-kant	5.5	6	8	10	12	16	20
4-höjd	4	4	5	6	8	12	15
Längd	C:A PRIS/100 ST						
12		X					
16	X	X	X				
20	X	X	X	X			
25	X	X	X	X	X		
30	X	X	X	X	X		
35	X	X	X	X	X		
40	X	X	X	X	X	X	
45	X	X	X	X	X	X	
50	X	X	X	X	X	X	
55	X	X	X	X		X	
60	X	X	X	X	X	X	
65	X	X	X	X		X	
70	X	X	X	X	X	X	
75		X	X	X	X	X	
80	X	X	X	X	X	X	X
90	X	X	X	X	X	X	X
100		X	X	X	X	X	X
110		X	X	X	X	X	
120		X	X	X	X	X	X
130		X	X	X	X	X	
140		X	X	X	X	X	X
150		X	X	X	X	X	X
160			X	X	X	X	X
180			X	X	X	X	X
200			X	X	X	X	X
220				X	X	X	X
240				X	X	X	X
260				X	X	X	X
280				X	X	X	X
300				X	X	X	X

ÖVRIGA DIMENSIONER OCH LÄNGDER MOT FÖRFRÅGAN !

FÖRP.	M5	M6	M8	M10	M12	M16	M20
200 ST		12-	16-				
100 ST		60-	30-	30-			
50 ST			100-	65-	30-		
25 ST			180-	120-	80-	50-	100-
10 ST					260-		

BESTÄLLNINGSEXEMPEL: 11000210050 - MVBF M10X50 4.6 FZB

**SWEBOLT AB**

**TEL 08 - 555 975 00 FAX 08 - 583 581 82**



# ARTIKELLISTA

2013-2014

## RÖRPROPPAR DIN 906 - DIN 908 - DIN 910 OBEH - FOS - FZB

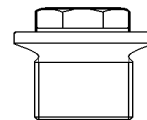

C:A PRIS/100 ST									
DIM	DIN 906			DIN 908			DIN 910		
	OBEH	FOS	FZB	OBEH	FOS	FZB	OBEH	FOS	FZB
M6x1	X								
M8x1		X			X				
M10x1		X		X	X				
M12x1.5		X			X	X			
M14x1.5		X		X	X		X		
M16x1.5		X		X	X				
M18x1.5		X		X	X		X		
M20x1.5		X					X		
M22x1.5				X	X		X		X
M24x1.5				X					
M26x1.5									
M27x2				X					
M30x1.5		X			X				
M30x2									
M33x2									
M36x1.5									
M36x2									
M38x1.5									
M42x1.5				X					
M42x2									
M45x1.5									
M45x2									
M48x1.5									
M48x2									

BESTÄLLNINGSEXEMPEL:  
 110051100 - RP 906 M10X1 5.8 FOSF  
 110050100 - RP 906 M10X1 5.8 OBEH  
 110056100 - RP 908 M10X1 5.8 FOSF  
 110055100 - RP 908 M10X1 5.8 OBEH

C:A PRIS/100 ST									
DIM	DIN 906			DIN 908			DIN 910		
	OBEH	FOS	FZB	OBEH	FOS	FZB	OBEH	FOS	FZB
R 1/8		X		X	X	X			
R 1/4		X			X	X			
R 3/8		X		X		X	X		
R 1/2		X			X		X		X
R 5/8									
R 3/4		X			X		X		X
R 7/8									
R 1		X							
R 1 1/8									
R 1 1/4									X
R 1 1/2									
R 1 3/4									
R 2									

ÖVRIGA DIMENSIONER MOT FÖRFRÅGAN !

FÖRP	OBEH	FOS	FZB	OBEH	FOS	FZB	OBEH	FOS	FZB
100 ST	M6-	M6-	M6-	M6-	M6-	M6-	M6-	M6-	M6-
50 ST	M12-	M12-	M12-	M12-	M12-	M12-	M12-	M12-	M12-
25 ST	M18-	M18-	M18-	M18-	M18-	M18-	M18-	M18-	M18-
10 ST	M27-	M27-	M27-	M27-	M27-	M27-	M27-	M27-	M27-

**SWEBOLT AB**

TEL 08 - 555 975 00 FAX 08 - 583 581 82

# ARTIKELLISTA

2013-2014

LYFTÖGLA TAPP - LT - DIN 580

LYFTÖGLA HÅL - LH - DIN 582

OBEH - FZB - FZV

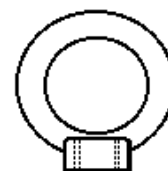
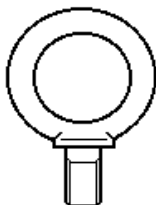

C:A PRIS/100 ST						
DIM	LT DIN 580			LH DIN 582		
	OBEH	FZB	FZV	OBEH	FZB	FZV
M6	X		X	X	X	X
M8	X		X	X	X	X
M10	X		X	X	X	X
M12	X		X	X	X	X
M16	X		X	X		X
M20	X		X	X		X
M24	X		X	X		X
M27	X			X		
M30	X		X	X	X	X
M36	X		X	X		X
M42	X			X		
M48	X					
M64						
M72						
<b>FÖRP.</b>	<b>OBEH</b>	<b>FZB</b>	<b>FZV</b>	<b>OBEH</b>	<b>FZB</b>	<b>FZV</b>
50 ST	M6-	M6-	M6-	M6-	M6-	M6-
25 ST	M12-	M12-	M12-	M12-	M12-	M12-
1 ST	M20-	M20-	M20-	M20-	M20-	M20-

BESTÄLLNINGSEXEMPEL: 110100100 - LT M10 C15 OBEH

BESTÄLLNINGSEXEMPEL: 110101100 - LT M10 C15 FZB

BESTÄLLNINGSEXEMPEL: 110102100 - LT M10 C15 FZV

BESTÄLLNINGSEXEMPEL: 110110100 - LH M10 C15 OBEH

BESTÄLLNINGSEXEMPEL: 110111100 - LH M10 C15 FZB

BESTÄLLNINGSEXEMPEL: 110112100 - LH M10 C15 FZV

ÖVRIGA DIMENSIONER OCH TAPPLÄNGDER MOT FÖRFRÅGAN !

**SWEBOLT AB**

TEL 08 - 555 975 00 FAX 08 - 583 581 82

# ARTIKELLISTA

2013-2014

## BLADHYLSA - VINGSKRUV - PENDELSKRUV

### BLADHYLSA

#### FZB



C:A PRIS/100 ST				
DIM	Bladbredd	Hål	Tot.längd	FZB
M6	16.74	6.2	43.7	X
M8	18.4	8.2	45.42	X
M10	21.49	10.2	51.22	X
M12	25.32	12.3	60.23	X

FÖRP	
100 ST	M6-
50 ST	M10-

BESTÄLLNINGSEXEMPEL: 110471080 - BLADHYLSA M8 FZB

### PENDELSKRUV PS

#### FZB



C:A PRIS/100 ST							
DIM	FZB	DIM	FZB	DIM	FZB	DIM	FZB
M8x50	X	M8x180	X	M8x320	X	M10x80	X
M8x60	X	M8x200	X	M8x340	X	M10x100	X
M8x80	X	M8x220	X	M8x360	X	M10x120	X
M8x100	X	M8x240	X	M8x380	X	M10x140	X
M8x120	X	M8x260	X	M8x400	X	M10x160	X
M8x140	X	M8x280	X	M10x50	X	M10x180	X
M8x160	X	M8x300	X	M10x60	X	M10x200	X

BESTÄLLNINGSEXEMPEL: 11042508100 - PS M8X100 FZB

FÖRP	
100 ST	tom. 300mm
50 ST	över 300mm

### VINGSKRUV VS DIN 316

#### FZB

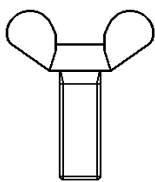

DIM	M3	M4	M5	M6	M8	M10	M12
NV	16	20	26	33	39	51	65
Höjd	8	10.5	13	17	20	25	33
Längd	C:A PRIS/100 ST						
8		X					
10		X	X	X			
12		X	X	X	X		
16	X		X	X	X	X	
20			X	X	X	X	X
25			X	X	X	X	X
30				X	X	X	X
35						X	X
40				X	X	X	X
50					X	X	X
60					X	X	
70					X		
80							

BESTÄLLNINGSEXEMPEL: 11022110016 - VS M10X16 FZB

FÖRP	M3	M4	M5	M6	M8	M10	M12
200 ST	8-	8-	8-	8-			
100 ST				16-	10-		
50 ST					40-	16-	
25 ST							20-

## SWEBOLT AB

TEL 08 - 555 975 00 FAX 08 - 583 581 82

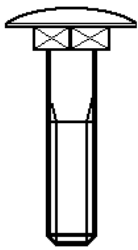

**ARTIKELLISTA**  
**2013-2014**  
**VAGNSBULT**  
**DELTA**  
**MVBF 4.6 DEPO DIN 603**

GÄNGA	M6	M8	M10	M12	M16	M20
Skalldiam	16	20	24	30	38	46
Skallhöjd	3.5	4.5	5	6.5	8.5	10.5
4-kant	6	8	10	12	16	20
4-höjd	4	5	6	8	12	15
Längd	C:A PRIS/100 ST					
12						
16		X				
20		X				
25		X	X			
30		X	X			
35		X	X			
40		X	X	X		
45		X	X	X		
50		X	X	X		
55		X	X	X		
60		X	X	X		
65		X	X			
70		X	X	X		
75						
80		X	X	X		
90		X	X	X		
100		X	X	X		
110		X	X	X		
120		X	X	X		
130		X	X	X		
140		X	X	X		
150		X	X	X		
160		X	X	X		
180		X	X	X		
200		X	X	X		
220			X	X		
240			X	X		
260			X	X		
280			X	X		
300			X	X		

ÖVRIGA DIMENSIONER OCH LÄNGDER MOT FÖRFRÅGAN !

FÖRP.	M6	M8	M10	M12	M16	M20
200 ST	12-	16-				
100 ST	60-	30-	30-			
50 ST		100-	65-	30-		
25 ST		180-	120-	80-	50-	100-
10 ST				260-		

BESTÄLLNINGSEXEMPEL: 71000210050 - MVBF M10X50 4.6 DEPO

**SWEBOLT AB**

**TEL 08 - 555 975 00 FAX 08 - 583 581 82**

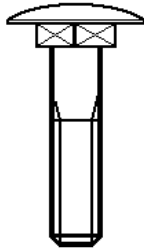

## ARTIKELLIISTA

2013-2014

VAGNSBULT

ROSTFRI A2

MVBF A2 DIN 603

DIM	M6	M8	M10	M12	M16
Skalldiam	16	20	24	30	39
Skallhöjd	3.5	4.5	5	6.5	9
4-kant	6	8	10	12	16.7
Höjd	4	5	6	8	12.9
Längd	C:A PRIS/100 ST				
16	X	X			
20	X	X			
25	X	X			
30	X	X		X	
35	X	X	X		
40	X	X	X	X	
45	X	X			
50	X	X		X	X
55	X	X			
60	X	X		X	
65	X				
70	X	X			
80	X	X			
90					
130	X				

BESTÄLLNINGSEXEMPEL: 21000108050 - MVBF M8X50 A2

SYRAFAST A4

MVBF A4 DIN 603

DIM	M6	M8	M10	M12	M16
Längd	C:A PRIS/100 ST				
16	X				
20	X	X			
25	X	X	X	X	
30	X	X	X	X	
35	X	X	X		
40	X	X	X	X	
45	X	X			
50	X	X	X	X	X
60	X	X	X	X	
65		X			
70	X	X	X	X	
80		X	X	X	
90		X	X		
100		X	X	X	
110		X			
120		X	X		

BESTÄLLNINGSEXEMPEL: 21000208050 - MVBF M8X50 A4

ÖVRIGA DIMENSIONER OCH LÄNGDER MOT FÖRFRÅGAN !

FÖRP.	M6	M8	M10	M12	M16
200 ST	16-				
100 ST	30-	20-	25-	25-	
50 ST				30-	50-

**SWEBOLT AB**

TEL 08 - 555 975 00 FAX 08 - 583 581 82

# ARTIKELLISTA

2013-2014

LYFTÖGLA TAPP - LT - DIN 580

LYFTÖGLA HÅL - LH - DIN 582

ROSTFRI A2, SYRAFAST A4

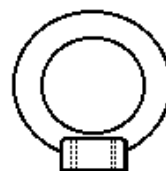
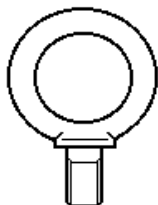

C:A PRIS/100ST				
DIM	LT DIN 580		LH DIN 582	
	A2	A4	A2	A4
M6	X	X	X	X
M8	X	X	X	X
M10	X	X	X	X
M12	X	X	X	X
M16	X	X	X	X
M20	X	X	X	X

BESTÄLLNINGSEXEMPEL: 210101120 - LT M12 A4

BESTÄLLNINGSEXEMPEL: 210111160 - LH M16 A4

ÖVRIGA DIMENSIONER OCH TAPPLÄNGDER MOT FÖRFRÅGAN !

**SWEBOLT AB**

TEL 08 - 555 975 00 FAX 08 - 583 581 82

# ARTIKELLISTA

2013-2014

## VS - VINGSKRUV DIN 316 A2 AM-FORM

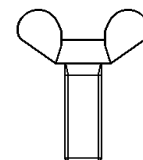

DIM	M3	M4	M5	M6	M8	M10	M12
Bredd	17.6	17.6	22.5	27.8	30.3	36.2	49.4
Höjd	8.6	8.6	11	13.6	14.8	17.7	24.1
Höjd inner	2.9	2.9	4.1	5.1	5.6	6.8	9
Längd	C:A PRIS/100						
10	X	X	X	X	X		
12	X	X	X	X	X		
16	X	X	X	X	X	X	
20	X	X	X	X	X	X	X
25	X	X	X	X	X	X	X
30	X	X	X	X	X	X	X
35		X	X	X	X	X	X
40		X	X	X	X	X	X
45			X	X	X	X	X
50			X	X	X	X	X
55					X	X	X
60					X	X	X
FÖRP.	M3	M4	M5	M6	M8	M10	M12
100 ST	10-	10-	10-				
50 ST				10-	10-	16-	
25 ST							25-
1 ST							

BESTÄLLNINGSEXEMPEL: 21022006020 - VS M6x20 A2

## VS - VINGSKRUV DIN 316 A4 AM-FORM

DIM	M3	M4	M5	M6	M8	M10	M12
Längd	C:A PRIS/100						
10	X	X	X	X	X		
12	X	X	X	X	X		
16	X	X	X	X	X	X	
20	X	X	X	X	X	X	X
25	X	X	X	X	X	X	X
30	X	X	X	X	X	X	X
35		X	X	X	X	X	X
40		X	X	X	X	X	X
45			X	X	X	X	X
50			X	X	X	X	X
55					X	X	X
60					X	X	X
FÖRP.	M3	M4	M5	M6	M8	M10	M12
100 ST	10-	10-	10-				
50 ST				10-	10-	16-	
25 ST							25-
1 ST							

BESTÄLLNINGSEXEMPEL: 21022106016 - VS M6x16 A4

**SWEBOLT AB**

TEL 08 - 555 975 00 FAX 08 - 583 581 82

10:44

# ARTIKELLISTA

2013-2014

## SVETSBULT ISO 13918 STÅL/KOPPARBEL - ALUMINIUM ROSTFRI A2 - MÄSSING

GÅNGA	M3				M4				M5			
D+/-0.1	4.5				5.5				6.5			
d1+/-0.08	0.6				0.65				0.75			
L1 +/-0.05	0.55				0.55				0.8			
h	0.7-1.4				0.7-1.4				0.7-1.4			
vinkel	3				3				3			
C:A PRIS / 100 ST												
DIM	STÅL	A2	AlMg3	MÄSS	STÅL	A2	AlMg3	MÄSS	STÅL	A2	AlMg3	MÄSS
6	X	X	X		X	X	X					
8	X	X	X		X	X	X		X	X		
10	X	X	X		X	X	X		X	X	X	
12	X	X	X		X	X	X		X	X	X	
15	X	X	X		X	X	X		X	X	X	
20	X	X	X		X	X	X		X	X	X	
25	X	X	X		X	X	X		X	X	X	
30	X	X	X		X	X	X		X	X		
35					X	X						
40					X	X						
FÖRP.	STÅL	A2	AlMg3	MÄSS	STÅL	A2	AlMg3	MÄSS	STÅL	A2	AlMg3	MÄSS
500 ST	6-	6-	6-		6-	6-	6-		6-	6-	6-	

GÅNGA	M6				M8			
D+/-0.1	7.5				9,0			
d1+/-0.08	0.75				0.82			
L1 +/-0.05	0.8				1.9			
h	0.7-1.4				0.7-1.4			
vinkel	3				3			
C:A PRIS / 100 ST								
DIM	STÅL	A2	AlMg3	MÄSS	STÅL	A2	AlMg3	MÄSS
6								
8	X	X	X					
10	X	X	X		X	X		
12	X	X	X		X	X		
15	X	X	X		X	X		
20	X	X	X		X	X		
25	X	X	X		X	X		
30	X	X	X		X	X		
35	X	X			X	X		
40	X	X			X	X		
FÖRP.	STÅL	A2	AlMg3	MÄSS	STÅL	A2	AlMg3	MÄSS
500 ST	8-	8-	8-		10-	10-		
200 ST		30-				20-		

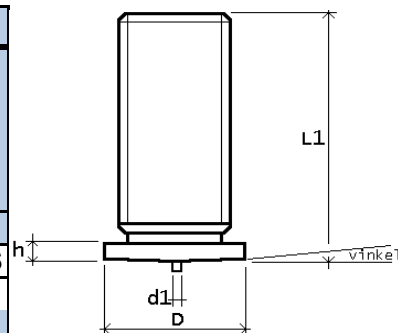

ÖVRIGA DIMENSIONER OCH LÄNGDER MOT FÖRFRÅGAN !

BESTÄLLNINGSEXEMPEL: 21080006015 - SVETSBULT M6X15 A2

**SWEBOLT AB**

TEL 08 - 55 975 00 FAX 08 - 583 581 82

10:80