



SWEBOLT AB

Skruvartiklar för varje ändamål !

Järfälla 08-55597500 info@swebolt.se
Tranås 0140-362300 tranas@swebolt.se
Norrköping 011-4507400 norrkoping@swebolt.se

Plugg för betong och skivmaterial

Sortimentet med plugg är stort, med produkter för snart sagt alla behov. Kvalitativa produkter från ledande tillverkare!



Exkl moms. Gäller 2018-08-01



THE ORIGINAL



SB Technical products

SWEBOLT - BOTNIA BOLT

★★★★★
HÖGSTA KREDITVÄRDIGHET
Swebolt Järfälla Aktiebolag
© CREDITSAFE | 2014-03-14

AAA[®]
Högsta kreditvärdighet

NORDCERT
Certifierad EN 1090-1



Originallet - med och utan krage

Standardplugg för massiva material och hålmaterial som bildar knut vid skivmaterial.



Exkl moms. Gäller 2018-08-01

Artickl TRI	Artikel TRIKA (krage)	FÖRP	Skruvdim	Borrdiam	Borrdjup	Sättdjup		
41701010002	TRI 5/31	41701110002	TRIKA 5/31	100	3-4mm	5mm	45mm	31mm
41701010005	TRI 6/36	41701110005	TRIKA 6/36	100	4-5mm	6mm	50mm	36mm
41701010006	TRI 6/51	41701110006	TRIKA 6/51	100	4-5mm	6mm	65mm	51mm
41701010008	TRI 7/36	41701110008	TRIKA 7/36	100	4,5-5mm	7mm	50mm	36mm
41701010009	TRI 7/51	41701110009	TRIKA 7/51	100	4,5-5mm	7mm	70mm	51mm
41701010011	TRI 8/51	41701110011	TRIKA 8/51	100	5-6mm	8mm	70mm	51mm
41701010016	TRI 10/61	41701110016	TRIKA 10/61	50	6-8mm	10mm	85mm	61mm
41701010018	TRI 12/71	41701110018	TRIKA 12/71	25	8-10mm	12mm	95mm	71mm
41701010020	TRI 14/75	41701110020	TRIKA 14/75	20	10-12mm	14mm	100mm	75mm

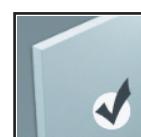
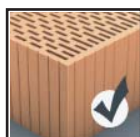

Tri	Betong C20/25	Tegel MZ 12	Håltegel	Hålsten min Hbl2	Lätbetong	Gips 13mm
5/31	25kg	15kg	15kg	10kg		6kg
6/36	50kg	35kg	25kg	15kg		10kg
6/51	60kg	40kg	25kg	20kg	10kg	10kg
7/36	60kg	40kg	25kg	25kg	10kg	10kg
7/51	60kg	50kg	25kg	25kg	10kg	10kg
8/51	100kg	80kg	30kg	25kg	15kg	10kg
10/61	130kg	80kg	35kg	28kg	20kg	
12/71	160kg	120kg	40kg	30kg	25kg	
14/75	200kg	140kg	40kg	35kg	25kg	





Barracuda - Höghållfast plugg

Stark plugg för betong och tegel. Fiskmunsöppning. 100% Nylon.

Exkl moms. Gäller 2018-08-01



Artikel	Dim	Förp	Betong C20/25	Tegel MZ 12	Skruvdiam	Borrdiam	Borrdjup	Sättdjup
417013100021	5/25	100	40kg	20kg	3-4mm	5mm	35mm	25mm
417013100041	6/30	100	70kg	35kg	3,5-5mm	6mm	45mm	30mm
417013100061	8/40	100	90kg	50kg	4-6mm	8mm	55mm	40mm
417013100081	10/50	50	200kg	80kg	6-8mm	10mm	70mm	50mm
417013100101	12/60	25	220kg	120kg	8-10mm	12mm	80mm	60mm
417013100121	14/70	20	230kg		10-12mm	14mm	95mm	70mm
417013100141	16/80	10	250kg		12mm	16mm	105mm	80mm

PSD Bizeps - Lång plugg

Plugg för stora sättdjup i porösa material och tjock infästning. 100% Nylon.



Artikel	Dim	Förp	Skruvdim	Borrdiam	Borrdjup	Sättdjup
41700910003	6/70	50	4,5-5	6mm	80mm	70mm
41700910005	8/90	50	5-6	8mm	100mm	90mm
41700910007	10/90	25	6-8/M8	10mm	100mm	90mm
41700910008	12/90	25	8-10/M10	12mm	100mm	90mm

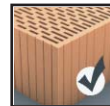
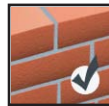

Artikel	Dim	Betong C20/25	Tegel MZ 12	Håltegel	Lättbetong
41700910003	6/70			30kg	15kg
41700910005	8/90	200kg	120kg	50kg	20kg
41700910007	10/90	250kg	140kg	60kg	25kg
41700910008	12/90	300kg	160kg	85kg	25kg





MKD Tiger - Metallplugg

Plugg 100% i metall för infästning i betong och porösa material. Idealiskt när nylon inte fungerar pga telexempel temperatur.



Exkl moms. Gäller 2018-08-01

Artikel	Dim	Förp	Skruvdiam	Borrdiam	Borrdjup	Sättdjup
41703910002	8/38	100	6-8mm	10-12mm	48mm	38mm
41703910003	8/60	100	6-8mm	10-12mm	70mm	60mm
41703910005	10/60	100	8-10mm	12-14mm	70mm	60mm

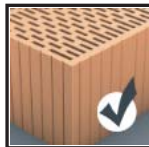

GB - Ytox lättbetonginplugg

Trekantig plugg för infästning i lättbetong och porösa material. Kraftig tredelad expansion.



Artikel	Dim	Förp	Borr	Skruv	Borrdjup	Sättdjup	Lättbetong
41709610004	10/55	25	8-10mm	4,5-6mm	65mm	55mm	25kg
41709610006	12/60	20	10-12mm	7-8mm	70mm	60mm	30kg
41709610008	14/75	10	12-14mm	10mm	85mm	75mm	40kg





"MOLLY" Acrobat - Skivankare

Plugg 100% i metall för infästning i skivmaterial.



Exkl moms. Gäller 2018-08-01

ARTIKEL	DIM	FÖRP	NYCKEL	BORR	SKIVA	Tfix	Gips 9,5mm	Gips 12,5mm	Gips 2x12,5mm	Fiberskiva 12,5mm	Plywood 10mm
1156050401	M4x32	50	PH2	8mm	3-11mm	23mm	15kg				25kg
1156050402	M4x38	50	PH2	8mm	8-16mm	20mm	15kg	20kg			25kg
1156050501	M5x37	50	PH2	10mm	6-13mm	21mm	15kg	20kg		30kg	30kg
1156050502	M5x52	50	PH2	10mm	7-18mm	28mm	15kg	20kg		30kg	30kg
1156050503	M5x65	25	PH2	10mm	17-32mm	28mm			20kg		
1156050601	M6x37	25	PH3	12mm	6-13mm	21mm	15kg	20kg		30kg	30kg
1156050602	M6x52	25	PH3	12mm	7-18mm	28mm	15kg	20kg		30kg	30kg
1156050603	M6x65	25	PH3	12mm	17-32mm	28mm			35kg		
1156050801	M8x55	50	NV 13mm	12mm	8-16mm	26mm	15kg	25kg			30kg
1156050802	M8x68	25	NV 13mm	12mm	17-32mm	27mm			35kg		

Monteringstång

Snabbverktyg för montering av skivankare Molly Acrobat.



Kort
Artikel 41703590094



Lång RAK
Artikel 41703590092





4AS-K Deco - Tandad plugg

Plugg med fyrdelad expansion. Tandad kropp som bildar knut vid skivmaterial och hålmaterial.



Exkl moms. Gäller 2018-08-01

Artikel	Dim	Förp	Skruv	Borrdiam	Borrdjup	Sättdjup
41701610001	5/25	100	3-4mm	5mm	35mm	24mm
41701610002	6/28	100	3,5-5mm	6mm	40mm	27mm
41701610003	6/41	100	3,5-5mm	6mm	50mm	40mm
41701610005	8/49	100	4-6mm	8mm	70mm	48mm
41701610008	10/66	50	6-8mm	10mm	80mm	65mm
41701610010	12/76	25	8-10mm	12mm	95mm	75mm

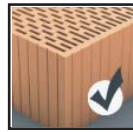

Dim	Betong C20/25	Tegel MZ12	Håltegel	Hålsten	Lättbetong	Gips 12,5mm
5/25	20kg	10kg	10kg	10kg		
6/28	40kg	30kg	15kg	10kg		
6/41	60kg	40kg	20kg	15kg	7kg	10kg
8/49	100kg	60kg	25kg	20kg	10kg	10kg
10/66	120kg	80kg	30kg	25kg	15kg	
12/76	130kg	100kg	40kg	40kg	20kg	





Spikplugg

Plugg med spik för slagmontage.

Pluggdiam	Borrdiam
5mm	5mm
6mm	6mm
8mm	8mm
10mm	10mm

Exkl moms. Gäller 2018-08-01

Artikel	Benämning	Förp
11541005025	SPIKPLUGG LK 5/25 FZB	200
11541005030	SPIKPLUGG LK 5/30 FZB	200
11541005040	SPIKPLUGG LK 5/40 FZB	200
11541005050	SPIKPLUGG LK 5/50 FZB	200
11541006035	SPIKPLUGG LK 6/35 FZB	100
11541006040	SPIKPLUGG LK 6/40 FZB	200
11541006050	SPIKPLUGG LK 6/50 FZB	200
11541006060	SPIKPLUGG LK 6/60 FZB	100
11541006080	SPIKPLUGG LK 6/80 FZB	100
11541008060	SPIKPLUGG LK 8/60 FZB	100
11541008080	SPIKPLUGG LK 8/80 FZB	100
11541008100	SPIKPLUGG LK 8/100 FZB	100



Stål FZB
Plan krage

Artikel	Benämning	Förp
11542005030	SPIKPLUGG UK 5/30 FZB	200
11542005050	SPIKPLUGG UK 5/50 FZB	200
11542006035	SPIKPLUGG UK 6/35 FZB	50
11542006040	SPIKPLUGG UK 6/40 FZB	200
11542006050	SPIKPLUGG UK 6/50 FZB	200
11542006060	SPIKPLUGG UK 6/60 FZB	100
11542006070	SPIKPLUGG UK 6/70 FZB	200
11542006080	SPIKPLUGG UK 6/80 FZB	100
11542008060	SPIKPLUGG UK 8/60 FZB	100
11542008080	SPIKPLUGG UK 8/80 FZB	100
11542008100	SPIKPLUGG UK 8/100 FZB	100
11542008120	SPIKPLUGG UK 8/120 FZB	50
11542008135	SPIKPLUGG UK 8/135 FZB	100
11542008140	SPIKPLUGG UK 8/140 FZB	50
11542008160	SPIKPLUGG UK 8/160 FZB	100



Stål FZB
Försänkt Krage

Artikel	Benämning	Förp
21541005030	SPIKPLUGG 5/30 A2	200
21541006040	SPIKPLUGG 6/40 A2	200
21541006060	SPIKPLUGG 6/60 A2	100
21541006080	SPIKPLUGG 6/80 A2	100
21541008060	SPIKPLUGG 8/60 A2	100
21541008080	SPIKPLUGG 8/80 A2	100



Rostfri A2
Plan krage





Fasadplugg 10mm

Polyamidplugg med metallskruv. Godkända för håltegel, massivt tegel, sprucken betong och osprucken betong.



Försänkt TORX FZB

Artikel	Benämning	Förp	Borrdiam	Borrdjup	Tfix	Grepp
11541710080	KAT 10x80 TORX FZB	50	10mm	60/80	30/10	T-40
11541710100	KAT 10x100 TORX FZB	50	10mm	60/80	50/30	T-40
11541710115	KAT 10x115 TORX FZB	50	10mm	60/80	65/45	T-40
11541710135	KAT 10x135 TORX FZB	50	10mm	60/80	85/65	T-40
11541710160	KAT 10x160 TORX FZB	50	10mm	60/80	110/90	T-40

Försänkt TORX Varmförzinkad

Artikel	Benämning	Förp	Borrdiam	Borrdjup	Tfix	Grepp
11541810080	KAT 10x80 TORX FZV	50	10mm	60/80	30/10	T-40
11541810100	KAT 10x100 TORX FZV	50	10mm	60/80	50/30	T-40
11541810115	KAT 10x115 TORX FZV	50	10mm	60/80	65/45	T-40
11541810135	KAT 10x135 TORX FZV	50	10mm	60/80	85/65	T-40
11541810160	KAT 10x160 TORX FZV	50	10mm	60/80	110/90	T-40

Sexkant med fläns FZB



Artikel	Benämning	Förp	Borrdiam	Borrdjup	Tfix	Grepp
11541910080	KAT 10x80 SEXKANT FZB	50	10mm	60/80	30/10	13mm
11541910100	KAT 10x100 SEXKANT FZB	50	10mm	60/80	50/30	13mm
11541910115	KAT 10x115 SEXKANT FZB	50	10mm	60/80	65/45	13mm
11541910135	KAT 10x135 SEXKANT FZB	40	10mm	60/80	85/65	13mm
11541910160	KAT 10x160 SEXKANT FZB	40	10mm	60/80	110/90	13mm

Sexkant med fläns Varmförzinkad

Artikel	Benämning	Förp	Borrdiam	Borrdjup	Tfix	Grepp
11542210100	KAT 10x100 SEXKANT FZV	50	10mm	60/80	50/30	13mm
11542210115	KAT 10x115 SEXKANT FZV	50	10mm	60/80	65/45	13mm
11542210135	KAT 10x135 SEXKANT FZV	40	10mm	60/80	85/65	13mm
11542210160	KAT 10x160 SEXKANT FZV	40	10mm	60/80	110/90	13mm

Exkl moms. Gäller 2018-08-01





Sharkie

Polyamidplugg för multiinfästning.
Universalplugg med fiskmunsfunktion
med stor expansion.



Artikel	Benämning	Förp	Borrdiam	Borrdjup
45407582	SHARKIE 6x30	100	6mm	35mm
45407584	SHARKIE 8x40	100	8mm	45mm

Exkl moms. Gäller 2018-08-01

NAT Polyamidplugg

Plugg för natursten, betong och massivt tegel.
Lämplig för trä och spånskiveskruv.
Temperaturområde -40°C till +80°C.
Lämplig skruvlängd = Plugglängd + fästmateriallets tjocklek + 5mm



Artikel	Benämning	Förp	Borrdiam	Borrdjup	Skruv	Draglast C20/25
11540105025	NYLONPLUGG 5x25 - NAT 5	100	5mm	30mm	2.5-4mm	0.6kN
11540106030	NYLONPLUGG 6x30 - NAT 6	100	6mm	35mm	3.5-5mm	0.9kN
11540108040	NYLONPLUGG 8x40 - NAT 8	100	8mm	45mm	4.5-6mm	1.4kN
11540108065	NYLONPLUGG 8x65 NAT 8 Lång	25	8mm	70mm	4.5-6mm	0.9kN Lättbetong
11540110050	NYLONPLUGG 10x50 - NAT 10	50	10mm	55mm	6-8mm	2.4kN
11540110080	NYLONPLUGG 10x80 NAT 10 Lång	25	10mm	85mm	6-8mm	1.2kN Lättbetong
11540112060	NYLONPLUGG 12x60 - NAT 12	25	12mm	65mm	8-10mm	3.3kN





Gummiexpander

Plugg och skivankare i gummi med ingjuten metallmutter.

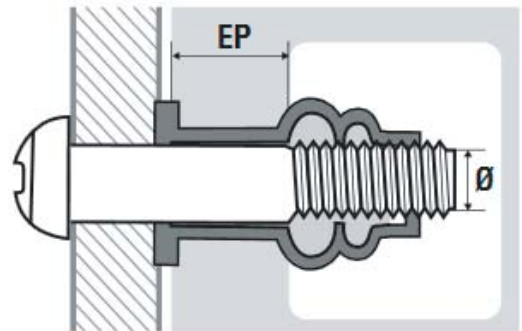

Exkl moms. Gäller 2018-08-01

Artikel	Benämning	Förp	EP	Borrdiam
4137000413	GUMMIEXPANDER M4x13	200	0,2-2mm	8mm
4137000514	GUMMIEXPANDER M5x14	200	0,2-2mm	10mm
4137000527	GUMMIEXPANDER M5x27	200	6-14mm	10mm
4137000540	GUMMIEXPANDER M5x40	200	19-26mm	10mm
4137000616	GUMMIEXPANDER M6x16	200	0,2-2mm	13mm
4137000627	GUMMIEXPANDER M6x27	200	3-13mm	13mm
4137000828	GUMMIEXPANDER M8x28	100	6-15mm	18mm
4137000850	GUMMIEXPANDER M8x50	100	25-35mm	18mm
4137001055	GUMMIEXPANDER M10x55	100	25-35mm	20mm
4137001280	GUMMIEXPANDER M12x80	100	33-45mm	24mm

Plåtexpander Spyder

Skivankare för tunnplåt 0,38-4,75mm.

Artikel	Benämning	Dim	Längd	FP	D2	Borr
41371040	PLÅTEXPANDER M4	M4	16.8mm	0.38-4.75mm	12.4mm	8mm
41371050	PLÅTEXPANDER M5	M5	18.4mm	0.38-4.75mm	14mm	10mm
41371060	PLÅTEXPANDER M6	M6	18.6mm	0.38-4.75mm	16mm	12mm
41371080	PLÅTEXPANDER M8	M8	25.5mm	0.38-4.75mm	18mm	15mm

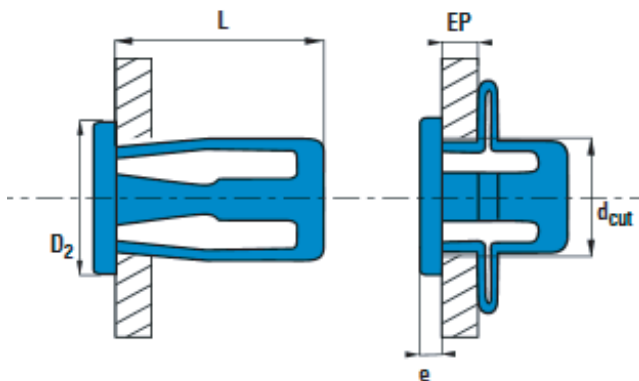



SWEBOLT AB

Skruvartiklar för varje ändamål !

Järfälla 08-55597500 info@swebolt.se
Tranås 0140-362300 tranas@swebolt.se
Norrköping 011-4507400 norrkoping@swebolt.se

Monteringsanvisning

Monter rätt med några enkla steg!



Exkl moms. Gäller 2018-08-01

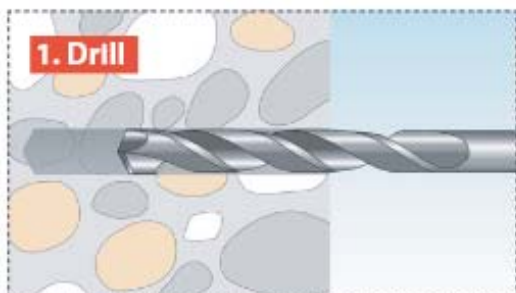

1. Drill

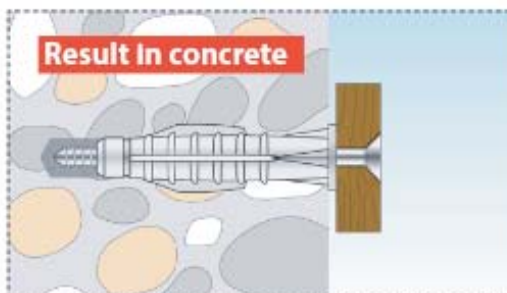

Result in concrete

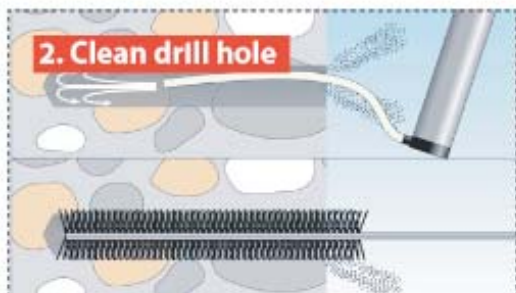

2. Clean drill hole

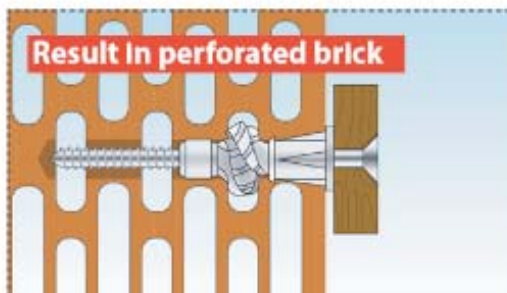

Result in perforated brick



3. Insert fixing

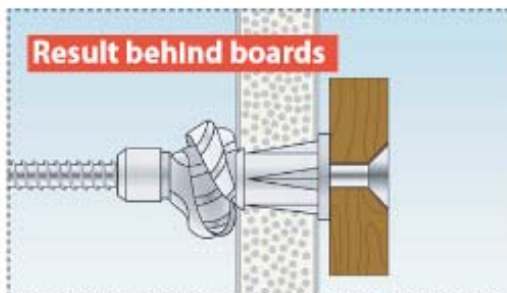

Result behind boards

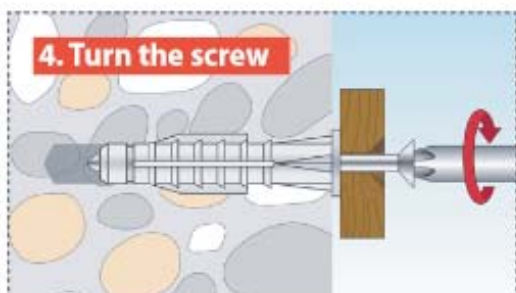

4. Turn the screw



SB Technical products

SWEBOLT - BOTNIA BOLT



HÖGSTA KREDITVÄRDIGHET
Swebolt Järfälla Aktiebolag
© CREDITSAFE | 2014-03-14



Högsta kreditvärdighet



Certifierad EN 1090-1



Betongborrar

3-skärig betongborr med SDS-fäste.

Exkl moms. Gäller 2018-08-01

Artikel	Benämning	Förp
603072B	BOOSTER SATS 6-14mm/160mm	1
60311305110	BOOSTER 5x110/50 SDS+	1
60311305160	BOOSTER 5x160/100 SDS+	1
603113055160	BOOSTER 5.5x160/100 SDS+	1
603113055210	BOOSTER 5.5x210/150 SDS+	1
603113060260	BOOSTER 6x260 SDS+	1
60311306110	BOOSTER 6x110/50 SDS+	1
60311306160	BOOSTER 6x160/100 SDS+	1
60311306210	BOOSTER 6x210/150 SDS+	1
60311306310	BOOSTER 6x310/250 SDS+	1
603113065110	BOOSTER 6.5x110 SDS+	1
603113065160	BOOSTER 6.5x160 SDS+	1
603113065210	BOOSTER 6.5x210 SDS+	1
603113065260	BOOSTER 6.5x260 SDS+	1
603113065310	BOOSTER 6.5x310 SDS+	1
60311307110	BOOSTER 7x110/50 SDS+	1
60311307160	BOOSTER 7x160/100 SDS+	1
60311307210	BOOSTER 7x210/150 SDS+	1
60311307310	BOOSTER 7x310/250 SDS+	1
60311308110	BOOSTER 8x110/50 SDS+	1
60311308160	BOOSTER 8x160/100 SDS+	1
60311308210	BOOSTER 8x210/150 SDS+	1
60311308260	BOOSTER 8x260 SDS+	1
60311308310	BOOSTER 8x310/250 SDS+	1
60311308460	BOOSTER 8x460/400 SDS+	1
60311308610	BOOSTER 8x610/550 SDS+	1
60311309310	BOOSTER 9x310 SDS+	1
60311310110	BOOSTER 10x110/50 SDS+	1
60311310160	BOOSTER 10x160/100 SDS+	1
60311310210	BOOSTER 10x210/150 SDS+	1
60311310260	BOOSTER 10x260 SDS+	1
60311310310	BOOSTER 10x310/250 SDS+	1
60311310460	BOOSTER 10x460/400 SDS+	1
60311310610	BOOSTER 10x610/550 SDS+	1
60311312160	BOOSTER 12x160/100 SDS+	1
60311312210	BOOSTER 12x210/150 SDS+	1
60311312260	BOOSTER 12x260 SDS+	1
60311312310	BOOSTER 12x310/250 SDS+	1
60311312460	BOOSTER 12x460/400 SDS+	1
60311312610	BOOSTER 12x610/550 SDS+	1
60311313160	BOOSTER 13x160/100 SDS+	1

